

D518[®]

OWNER'S MANUAL
MANUAL DEL USUARIO

JK-SUB12/LR

12" SUBWOOFER BOX LEFT AND RIGHT
FOR JEEPS JK/JKU

CAJA DE SUBWOOFER DE 12" IZQUIERDA
Y DERECHA PARA JEEPS JK/JKU

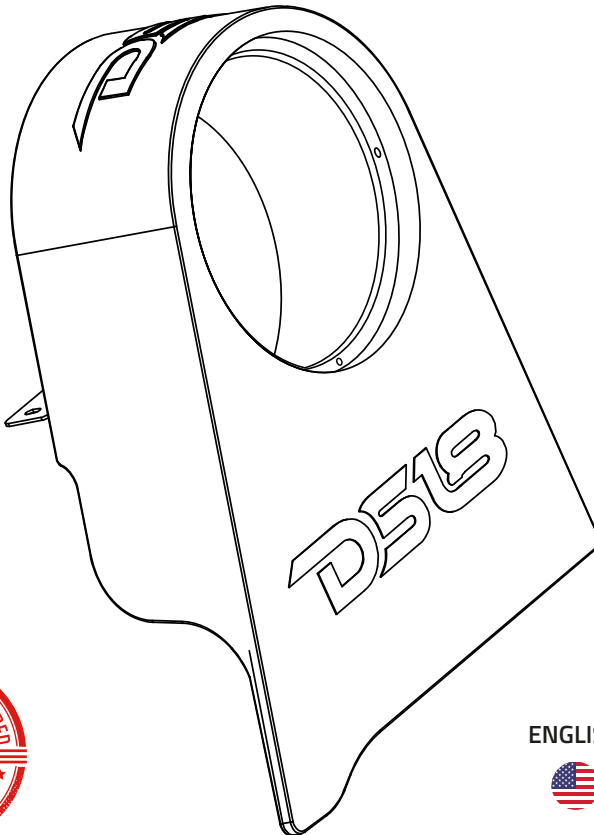

ENGLISH | ESPAÑOL



JK-SUB12/LR

12" SUBWOOFER BOX LEFT AND RIGHT FOR JEEPS JK/JKU

CAJA DE SUBWOOFER DE 12" IZQUIERDA Y DERECHA PARA JEEPS JK/JKU

FEATURES

- It is recommended to use the DS18 NXL-12SUB Subwoofer or another 12" subwoofer model (subwoofer not included).
- High density molded plastic with black color injected.
- UV protected and ready for all elements.
- Light weight and strong material.
- Mounting bracket and hardware included.
- 1 meter 6-core input cable (speaker input and RGB LED lights).
- Sealed-type Acoustic Box for quality bass sound with smooth and flat response.
- Internal volume area: 0.95 cubic feet / 27 liters.
- O.E.M. Fit.

CARACTERÍSTICAS

- Se recomienda usar el Subwoofer DS18 NXL-12SUB u otro modelo de subwoofer de 12" (subwoofer no incluido).
- Plástico de alta densidad moldeado con color negro inyectado.
- Protegido contra los rayos UV y listo para todos los elementos.
- Peso ligero y material fuerte.
- Soporte de montaje y tornillería incluidos.
- Cable de entrada de 6 núcleos de 1 metro (entrada de altavoz y luces LED RGB).
- Caja acustica de tipo sellado para un bajo de calidad de sonido con una respuesta suave y plana.
- Área de volumen interno: 0,95 pies cúbicos / 27 litros.
- Ajusta como original de fabrica.



INSTALLATIONS STEPS

PASOS DE INSTALACIÓN

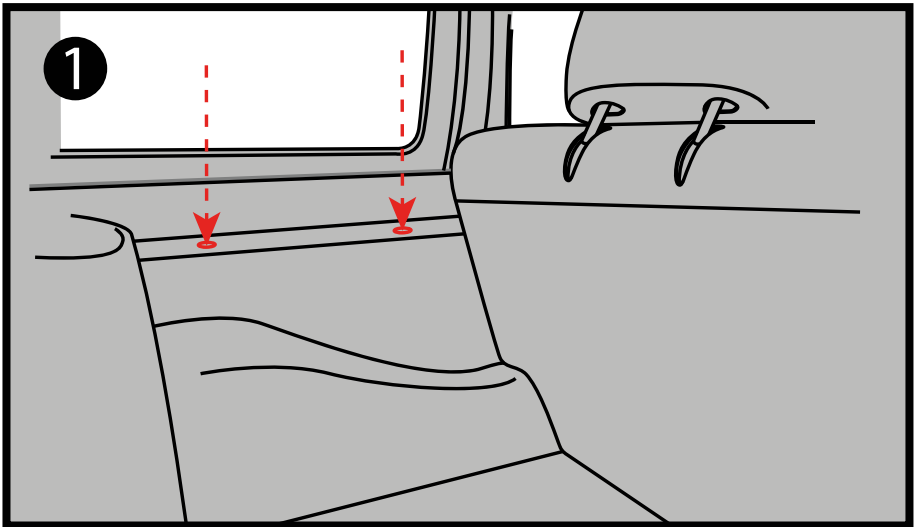

1. Locate the roof mounting bolts as shown (behind the rear seat above the wheel well), for JK models (2 doors) it is only recommended when the rear seat is removed.

1. Ubique los pernos de montaje del techo como se muestra (detrás del asiento trasero encima del hueco de la rueda), para los modelos JK (2 puertas) solo se recomienda cuando se retira el asiento trasero.

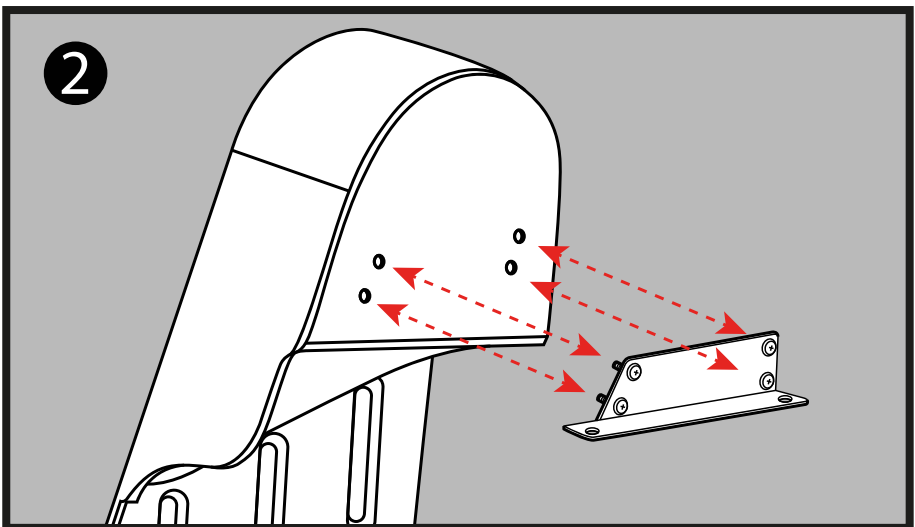

2. Attach mounting bracket to enclosure as shown, using supplied hardware.

2. Fije el soporte de montaje al gabinete como se muestra, usando el hardware suministrado.

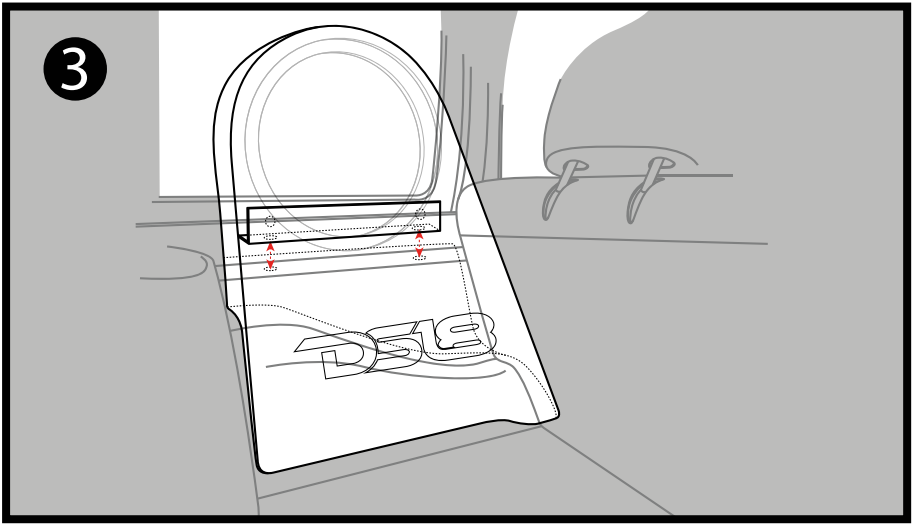

3. When the bracket is assembled to the enclosure, this would be how the bracket mounts to the vehicle (This is for reference only!)

3. Cuando el soporte se ensambla en el gabinete, así sería como se monta el soporte en el vehículo (¡Esto es sólo como referencia!)

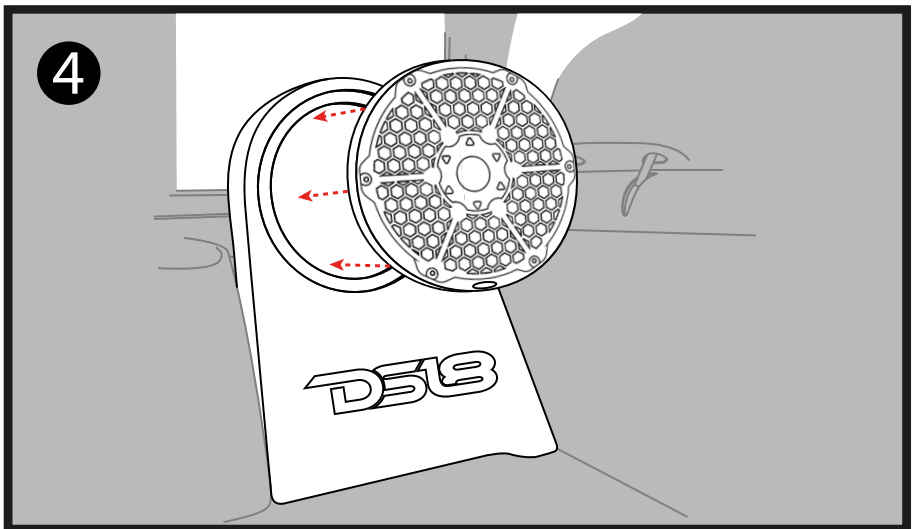

4. Install the Subwoofer into the box by connecting all its wires and securing with regular wood screws. Make all wire connections (see page 2) and mount the enclosure in place using the bolts you removed from the roof mounting location in Step 1.

4. Instale el Subwoofer en la caja conectando todos sus cables y asegurándolo con tornillos de madera regulares. Realice todas las conexiones de cables (vea la página 2) y monte el gabinete en su lugar usando los pernos que quitó de la ubicación de montaje en el techo en el Paso 1.

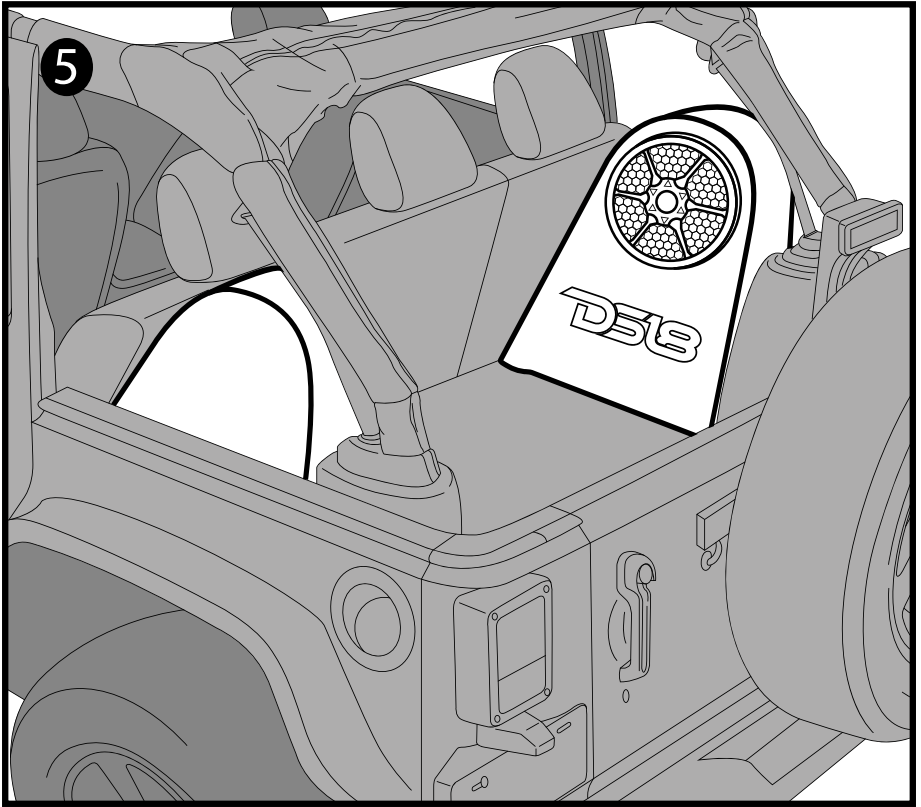

5. Your installation is complete. Enjoy your new Bass!!

5. Su instalación está completa. Disfruta de tu nuevo bajo.

△ ▲ **FOR ALL**
ELEMENTS ≡

WIRING

CABLEADO





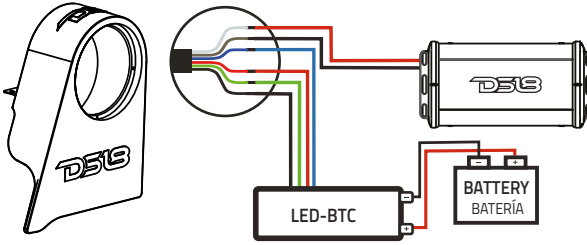

INSTALLATION & CONNECTION OPTIONS

If you have an LED Control Module (LED-BTC), Connect as Shown in the Following Diagram:



OPCIONES DE CONEXIÓN E INSTALACIÓN

Si tiene un módulo de control LED (LED-BTC), conéctelo como se muestra en el siguiente diagrama:

	Blue LED (-) LED Azul (-)
	Red LED (-) LED Rojo (-)
	Green LED (-) LED Verde (-)
	Black 12V DC (+) 12V DC Negro (+)
	White Speaker (+) Altavoz Blanco (+)
	Grey Speaker (-) Altavoz Gris (-)





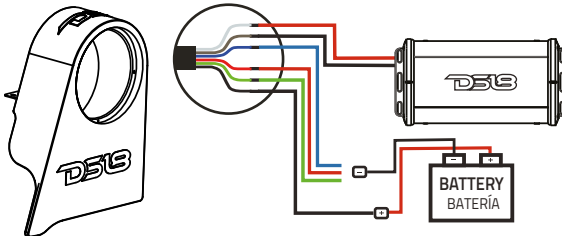

To connect without LED Control Module (LED-BTC), Connect as Shown in the Following Diagram:

- Black wire "BK" connected to battery Positive (+) 12V
- White Color Light "R"; "B" and "G" connected to battery Negative (-)
- Green Color Light "G" connected to battery Negative (-)
- Red Color Light "R" connected to battery Negative (-)
- Blue Color Light "B" connected to battery Negative (-)
- Purple Color Light "R" and "B" connected to battery Negative (-)
- Yellow Color Light "R" and "G" connected to battery Negative (-)
- Cyan Color Light "B" and "G" connected to battery Negative (-)

Para conectarse sin el módulo de control LED (LED-BTC), conecte como se muestra en el siguiente diagrama:

- Cable negro "BK" conectado al positivo de la batería (+) 12V
- Luz de color blanco "R"; "B" y "G" conectados al negativo de la batería (-)
- Luz de color verde "G" conectada al negativo de la batería (-)
- Luz de color roja "R" conectada al negativo de la batería (-)
- Luz de color azul "B" conectada al negativo de la batería (-)
- Luz de color púrpura "R" y "B" conectada al negativo de la batería (-)
- Luz de color amarillo "R" y "G" conectada al negativo de la batería (-)
- Luz de color cian "B" y "G" conectada al negativo de la batería (-)



	Blue LED (-) LED Azul (-)
	Red LED (-) LED Rojo (-)
	Green LED (-) LED Verde (-)
	Black 12V DC (+) 12V DC Negro (+)
	White Speaker (+) Altavoz Blanco (+)
	Grey Speaker (-) Altavoz Gris (-)

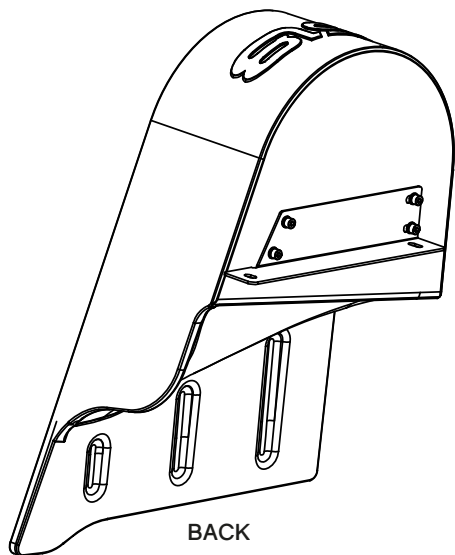

BACK

JK-SUB12/LR

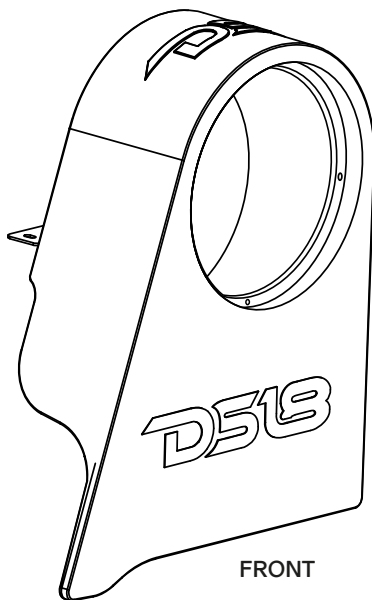

FRONT



WARRANTY

Please visit our website DS18.com for more information on our warranty policy.

We reserve the right to change products and specifications at any time without notice. Images may or may not include optional equipment.

GARANTIA

Visita nuestra página web DS18.com para obtener más información sobre nuestra garantía.

Nos reservamos el derecho de cambiar productos y especificaciones en cualquier momento sin previo aviso. Las imágenes pueden incluir o no equipo opcional.



FOR MORE INFORMATION
PLEASE VISIT
DS18.COM

WE LIKE IT LOUD

DS18[®]